

la classe



l'arbre



la tarte



le ballon



la salade



malade



Il est

la carte



La de France

la table



le chat



mardi



lundi
.....
mercredi
jeudi
vendredi

une banane



la glace



le sable



une dune de dans le désert

le jardin



C'est un beau

le lapin



une vache



la tartine



le journal



l'avion



le nuage



samedi



mercredi
jeudi
vendredi
.....
dimanche

l'ami



Mickey est l'..... de Donald et de Dingo.

une amie

un ami ⇨ une

une balle



une de tennis

la date

Lundi 3 janvier

A l'école, tous les matins,
j'écris la dans mon cahier.

il va



Il à l'école.

elle va



Elle à l'école.

blanche



une souris

blanc



Le lait est

je mange



Je ma soupe.

elle mange



Elle une feuille.

enfin



Je suis en retard,
mais j'arrive

les enfants



prendre



Il aime son bain.

dimanche



mercredi
jeudi
vendredi
samedi
.....

vendredi



mercredi
jeudi
.....
samedi
dimanche

une orange



cinquante



cent



soixante



trente



grand
(grande)

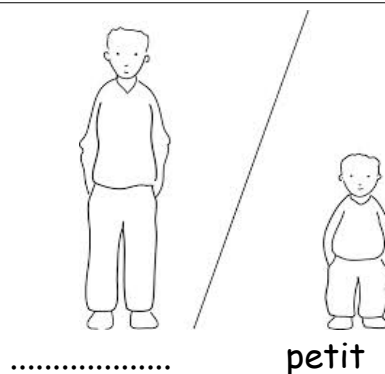

une branche



une d'arbre

dans



Winnie et ses amis jouent la rivière.

les enfants



entre



Winnie est Porcinet et Tigrou.

encore



Winnie a mangé tout le miel,
mais il a faim !

quarante



Marie-Cécile @ École de crevette

un **b**ateau



bleu



un ballon

bleue



une voiture

un **b**é**b**é



une **b**ranche



une d'arbre

un **b**allon



blanche



une souris

blanc



Le lait est

bonjour



B.....

Tous les matins, il dit « B..... ».

un ar**b**re



une **b**anane



une **b**ouche



la ruche



la niche



Le chien est dans sa

blanche



une souris

la louche



dimanche



mercredi
jeudi
vendredi
samedi

.....

la **ch**ambbre



Cette pièce s'appelle : la

la v**ach**e

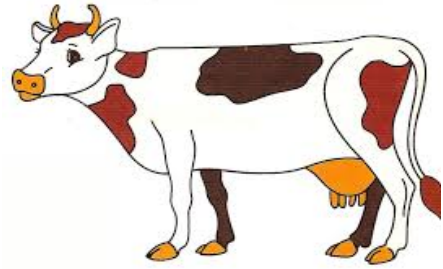

chaud



Il transpire, il a très

sa **douch**e



Il prend sa

le **che**val



un **ch**ien



du **ch**ocolati



un **ch**apeauu



au mar**ch**é



Ces gens sont au

une branche



une d'arbre

chez



Elle rentre elle.

une mouche



Marie-Cécile @ École de crevette

dans



Winnie et ses amis jouent la rivière.

le jardin



la salade



douze

12

lundi
mardi
mercredi
jeudi

vendredi
samedi
dimanche

Écris le nom des 7 jours de la semaine.

du monde

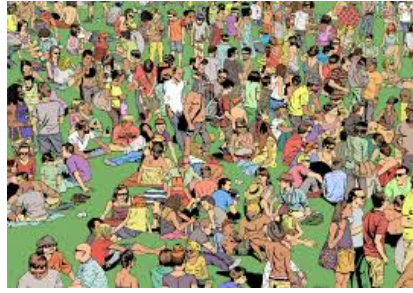

Il y a du dans le parc.

malade



Il est !

dix



deux



dormir



bleue



une robe

bleu



un pull

deux



neuf



la semaine

lundi
mardi
mercredi
jeudi
vendredi
samedi
dimanche

les jours de la
.....

le feu



le cheval



la fleur



elle a peur



ma couleur



Le rouge est ma préférée.

jeudi



mercredi
.....
vendredi
samedi
dimanche

vendredi



mercredi
jeudi
.....
samedi
dimanche

mercredi



lundi
mardi
.....
jeudi
vendredi

petit

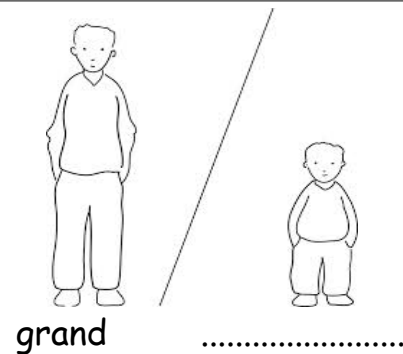

le chemin



Le traverse la forêt.

samedi



mercredi
jeudi
vendredi
.....
dimanche

Marie-Cécile @ École de crevette

une **saison**

Printemps

Été

Automne

Hiver

les quatre

.....

la **semaine**

lundi
mardi
mercredi
jeudi
vendredi
samedi
dimanche

les jours de la

.....

la **neige**



les flocons de

le **zèbre**



treize



mon père

C'est moi.



mon

ma mère

C'est moi.



ma

mon frère

C'est moi.



mon

le lait



vert
(verte)

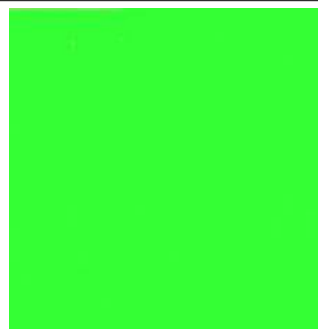

sept



seize



un(e) élève



En classe, un enfant s'appelle un
(ou une)

la terre



elle aime

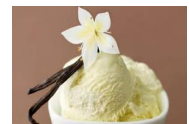

Elle la glace à la vanille.

il aime



Il le chocolat.

j' aime

J' le chocolat.



le soleil



avec



Winnie joue dans la neige Porcinet
et Tigrou.

après

avant /

merci

S'il te plaît...

.....

très



Il est vraiment en retard.

une idée



Elle a une !

du marché



C'est le jour du

un bébé



une année



Le 1^{er} janvier, on dit « Bonne ».

la fusée

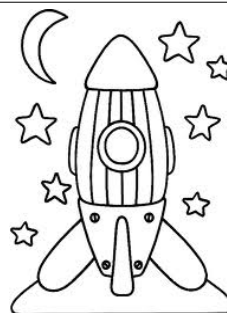

la

le café



un carré

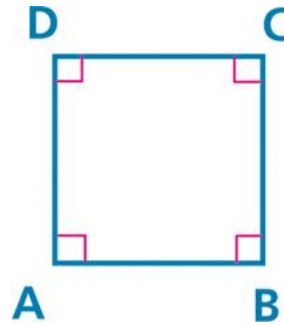

une poupée



une en tissu

une école



l'été

le printemps



l'automne

l'hiver

une étoile



une matinée

un matin ⇒ une

une journée

un jour ⇒ une

chez



Elle rentre elle.

j'ai **f**ait



Hier, j'..... un beau dessin.

j'ai **f**ini



Ouf, j'..... presque mon travail.

il **a** fini



Ouf, il presque mon travail.

la **f**leur

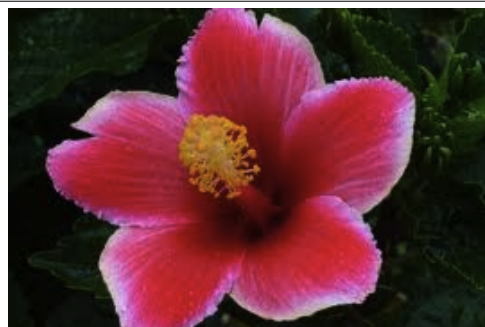

une girafe



froid



Brrr ! J'ai !

le feu



le café



la fusée

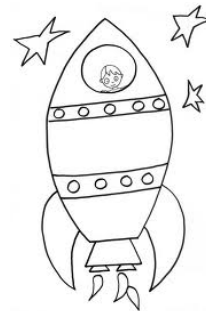

la

neuf



une fille



un garçon une

une famille



une

du fromage



mon frère

*C'est
moi.*



mon

gros
(grosse)

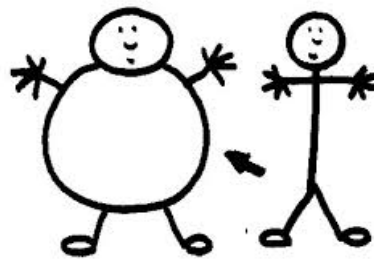

..... maigre

une **bague**



une **guitare**



une **vague**



grosse

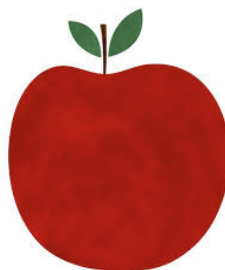

une pomme une petite pomme

une **g**lace



un **g**arçon



une fille un

gris
(grise)

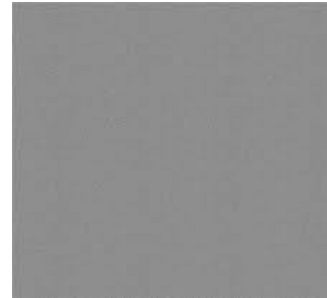

un **g**âteau



grand
(grande)

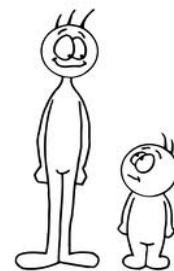

..... petit

il a gagné



Il la course.

j' ai gagné



je gagne



la montagne



la campagne



l'ami



Mickey est l'..... de Donald et de Dingo.

la tartine



mardi



lundi
.....
mercredi
jeudi
vendredi

le lit



de musique

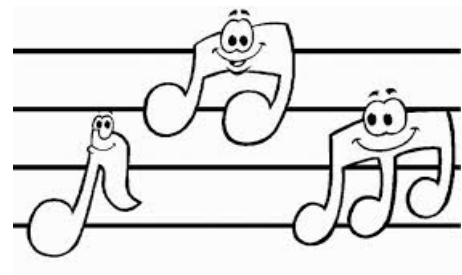

des notes de

un animal



Le tigre est un sauvage.

six



dix



sa niche



Le chien est dans sa

une fille



une

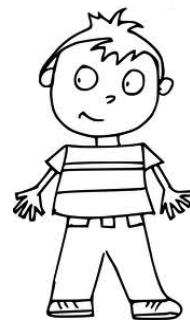

un garçon

petit

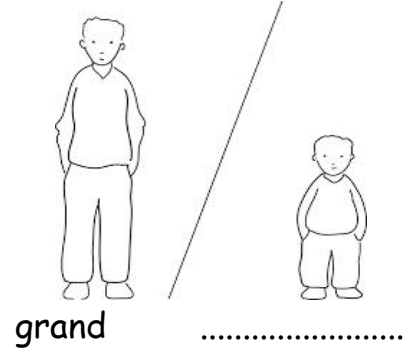

une minute



On court encore une

un livre



le tigre



gris
(grise)

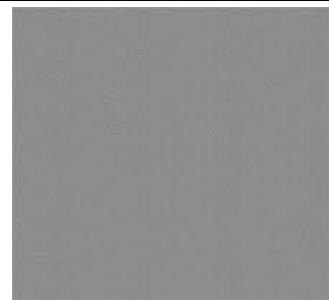

midi

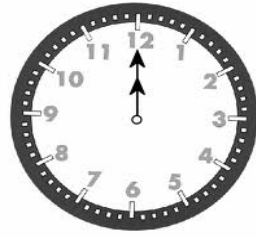

Il est, j'ai faim !

un camion



un chien



le soleil



un avion



une fille

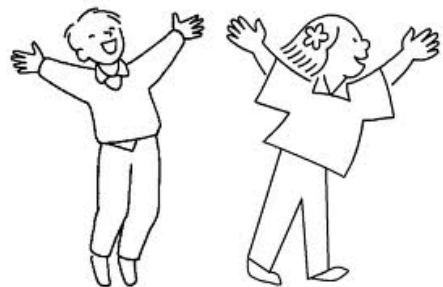

un garçon une

une famille



un lion



un indien



un papillon



le sapin



un chien



le pain



le train

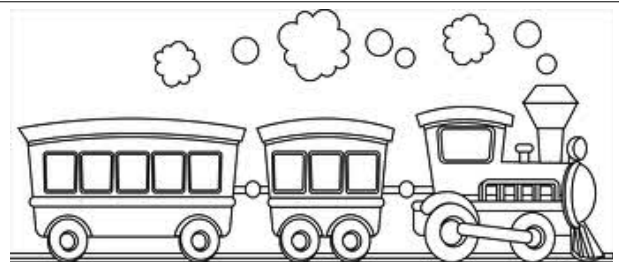

la main



quinze



demain

HIER

AUJOURD'HUI



vingt



le chemin



Le traverse la forêt.

cinq



cinquante

50

un copain

une copine ⇒ un

le jardin



rouge



le nuage



bonjour

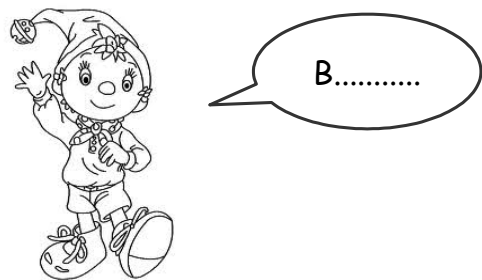

Tous les matins, il dit « B..... ».

le jour



est le premier
de la semaine.

jeudi



mercredi

.....

vendredi

samedi

dimanche

son visage



Elle lave son tous les soirs.

le genou

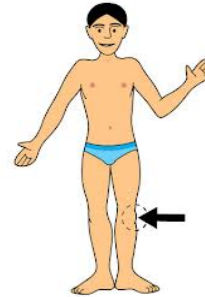

une journée

un jour ⇒ une

le journal



jaune



la jambe



une orange



la neige



les flocons de

une girafe



du fromage



il **j**oue



Il au tennis.

elle **j**oue



Elle à la marelle.

un orage



Il y a beaucoup d'éclairs et de coups de tonnerre, c'est un gros

orange



un **s**inge

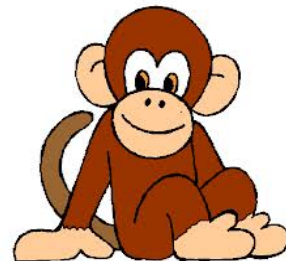

la **c**ouleur



Le jaune est une lumineuse.

la **l**ecture



Ils font de la

l'**é**criture



Il fait de l'

une **c**opine

un copain ⇒ une

son **c**opain

sa copine ⇒ son

le **c**oude



quarante



cin**q**



quatre



de **c**onfiture



des pots de

de sucre



des morceaux de

une carte



une du monde

une école



le café



un carré

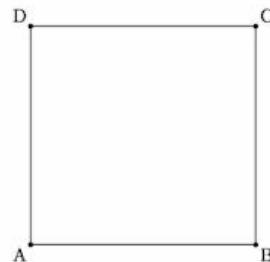

un **c**adeau



un **c**amion



cin**q**uante



une **c**lasse



la **c**ave

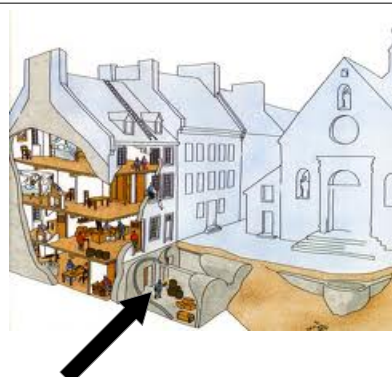

quinze



quatorze



parce que

Pourquoi es-tu en retard ?

Je suis en retard j'ai raté mon bus.

pourquoi

..... es-tu en retard ?

Je suis en retard parce que j'ai raté mon bus.

du chocolat



le lion



un lit

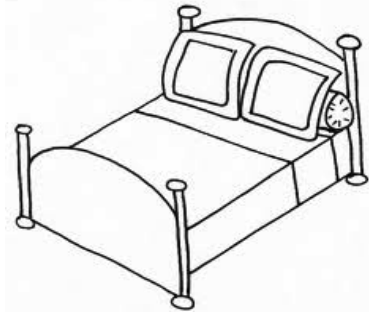

le journal



le cheval



une balle



une de tennis

un animal



Le crocodile est un sauvage.

une fleur



ma couleur



Le rouge est la préférée.

lundi



.....
mardi
mercredi
jeudi
vendredi

la salade



le lutin



un de Noël

le lapin



un ballon



l'école



la lune



il **l**it



il

le **l**ivre



du chocol**l**at



le **m**outon



la **m**ontre



la **pomme**

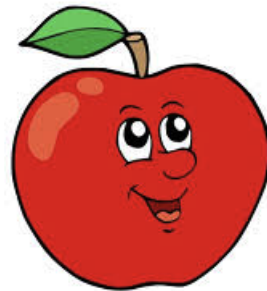

un **m**ur



un en pierres

une **m**aison



le chemin



Le traverse la forêt.

mardi



lundi

.....
mercredi
jeudi
vendredi

mercredi



lundi
mardi

.....
jeudi
vendredi

ce matin

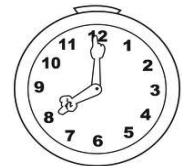

Ce, je me suis réveillé
à 8 heures.

de musique



des notes de

midi

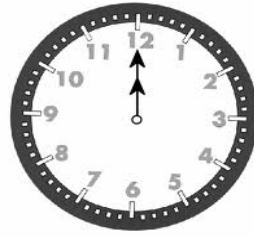

Il est, j'ai faim !

un animal



Le guépard est un sauvage.

l'ami



Mickey est l'..... de Donald et de Dingo.

une amie

un ami ⇨ une

malade



Il est !

la semaine

lundi
mardi
mercredi
jeudi
vendredi
samedi
dimanche

les jours de la

.....

le journal



la tartine



un animal



Le guépard est un sauvage.

une copine

un copain ⇒ une

jaune

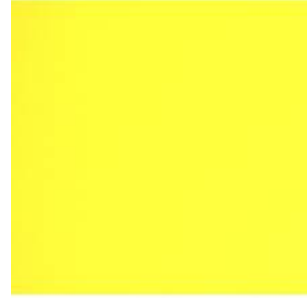

une année



Le 1^{er} janvier, on dit « Bonne ».

noire



une voiture

un nid



noir



un chat

un oiseau



pauvre



Il n'a pas d'argent, il est

le dos



Il frotte son

chaud



Il transpire, il a très

la robe



une pomme



un cadeau



un bateau



jaune



un chapeau



quatorze



rose

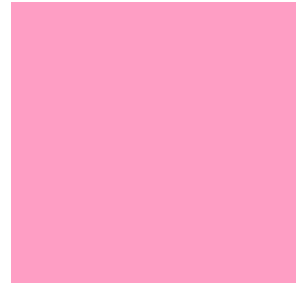

gros
(grosse)

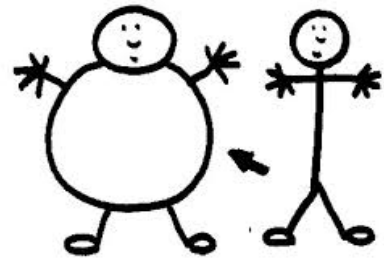

..... maigre

un gâteau



du chocolat



trois

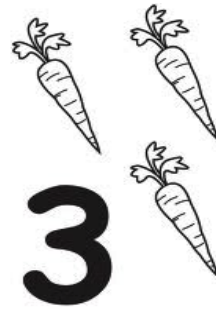

soixante



la voiture



noire



une poule

le soir



Le, le soleil se couche.

une poire



un poisson

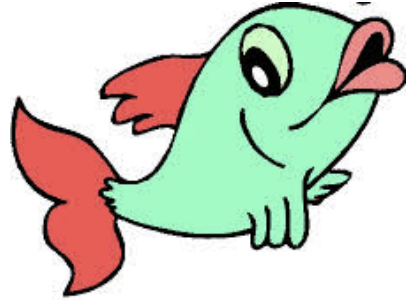

un oiseau



noir

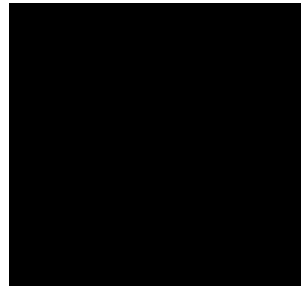

une étoile



froid



Brrr ! J'ai !

une ardoise



une

noir



un chat

noire



une voiture

le ballon



bonjour



B.....

Tous les matins, il dit « B..... ».

marron

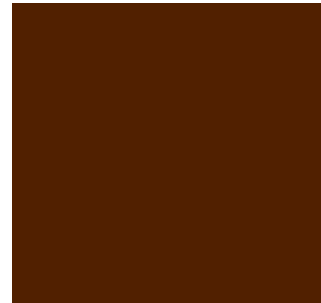

un poisson



du monde



la carte du

un lion



une maison



je raconte



Je une histoire à ses amis.

de confiture



des pots de

un camion



un avion

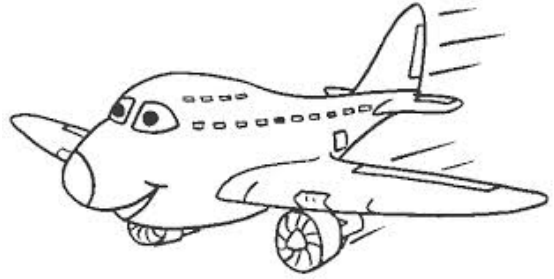

onze



la montagne



il monte



Il dans le bus.

un garçon



un une fille

une montre



un cochon



du coton



du

le genou

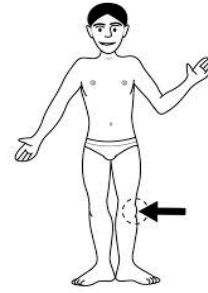

le

la bouche



la

bonjour

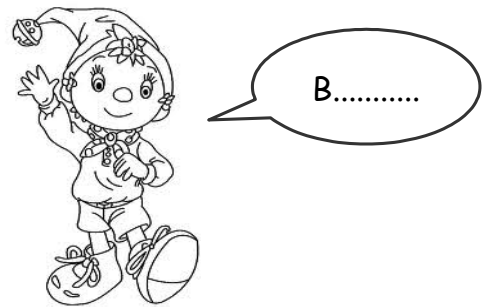

Tous les matins, il dit « B..... ! »

le coude

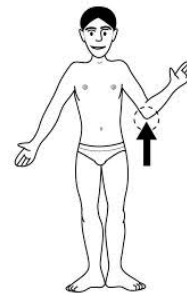

le

la poule



le mouton



la route



le journal



de soupe



un bol de

rouge

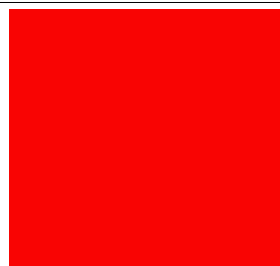

un jour



Lundi est le premier
de la semaine.

sous



la trousse

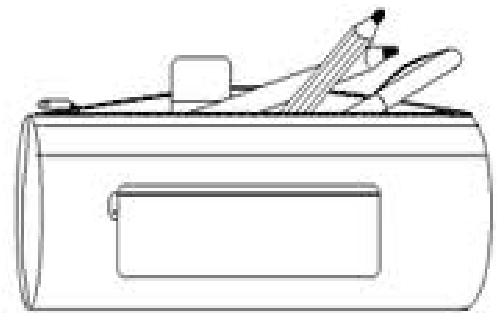

la route



douze



elle joue



Elle à la marelle.

il joue



Il au tennis.

vous



..... chantez

nous



..... chantons

je joue



Je
avec mon camion.

sa **douche**



Il prend sa

pourquoi

..... es-tu en retard ?

Je suis en retard parce que
j'ai raté mon bus.

une plume



la soupe



il a peur



Il a !

un lapin



une poule



une poire

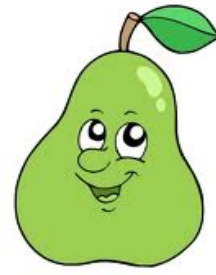

une copine

un copain ⇒ une

petit

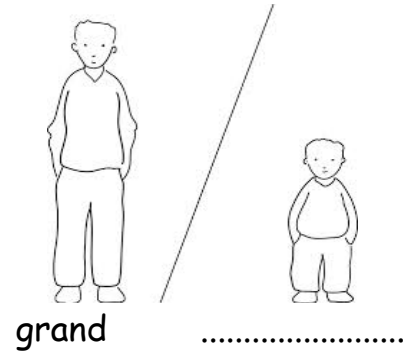

mon père

C'est moi.



mon

après

avant /

une poupée



une en tissu

une pomme



la porte



le sapin



du sucre



la porte



la route



le journal



la robe



la fleur



le soir



Le, le soleil se couche.

une carte



une du monde

un carré

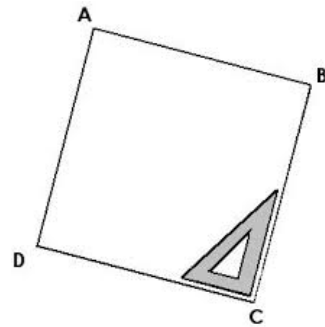

un _____

quatre



noire



une poule

sur



Winnie est assis un tronc d'arbre.

peur



Elle a

gris
(grise)



la voiture



un jour



est le premier
de la semaine.

le livre



Il lit un

la rue



grise



une souris

trois



grosse

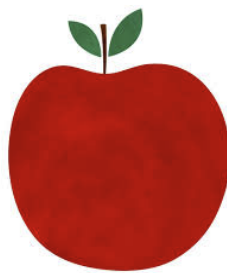

une pomme une petite pomme

une classe



une tasse



dix



soixante



sept



six



un garçon

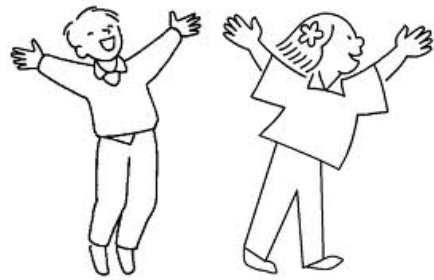

un une fille

seize



cent



cinquante



une glace



la semaine

lundi
mardi
mercredi
jeudi
vendredi
samedi
dimanche

les jours de la
.....

une saison

Printemps

Été

Automne

Hiver

les quatre
.....

de sucre



des morceaux de

le **s**oir



Le, le soleil se couche.

le **s**apin



un poi**s**son

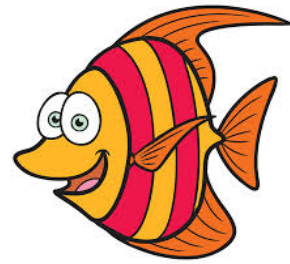

sur



Winnie est assis un tronc d'arbre.

sou**s**



Winnie fait un pique-nique
..... un arbre.

un citron



la France

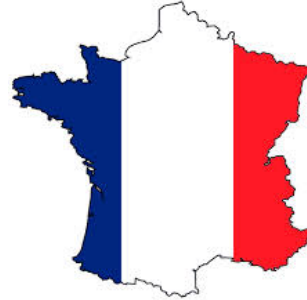

une place



C'est une réservée aux personnes handicapées.

merci

S'il te plaît...

.....

la trousse

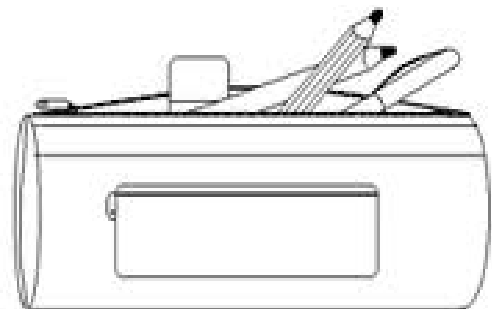

la **t**erre



de la

le mou**t**on

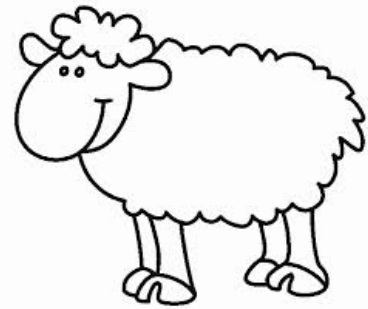

trois

3

vi**t**e



Il court très

qua**t**re

4

la tartine



petit

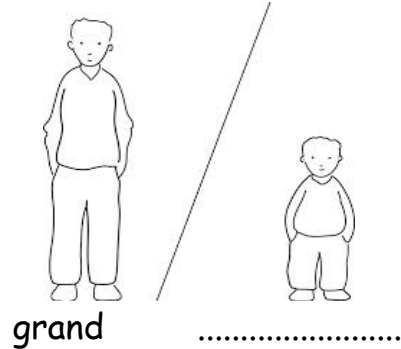

la route



la table



la date

Lundi 3 janvier

A l'école, tous les matins,
j'écris la dans mon cahier.

l'été

le printemps

.....

l'automne

l'hiver

la confiture



des pots de

la porte



une carte



une du monde

huit



trente



quarante



cinquante



soixante



huit



la cuisine



la pluie



La tombe.

aujourd'hui

hier

.....

demain

un(e) élève



En classe, un enfant s'appelle un
(ou une)

un avion

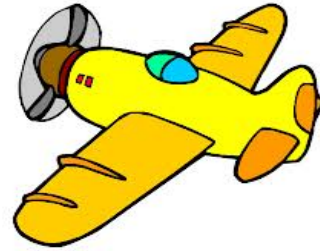

violet



le veau



Le petit de la vache s'appelle le

vendredi



mercredi

jeudi

.....

samedi

dimanche

verte



L'herbe est

la cave

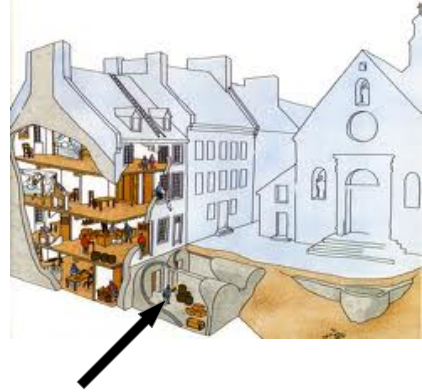

une ville



New-York est une grande

vert
(verte)



vingt



le cheval



son visage



Elle lave son tous les soirs.

Marie-Cécile @ École de crevette

seize

16

onze

11

le zèbre



douze

12

treize

13

quatorze



quinze



une saison

Printemps

Eté

Automne

Hiver

les quatre

.....

son visage



Elle lave son tous les soirs.

grise



une souris

une ardoise



une fusée



une

de musique



des notes de

zéro



un oiseau



une fraise



une maison



rose

